

SK NÁVOD NA MONTÁŽ
 CZ MONTÁŽNÍ NÁVOD
 HU SZERELÉSI UTASÍTÁS
 DE MONTAGEANLEITUNG

INVITA TYP 2

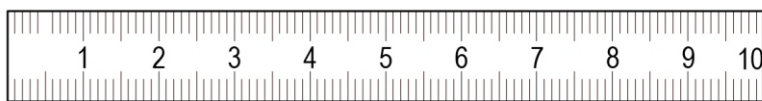

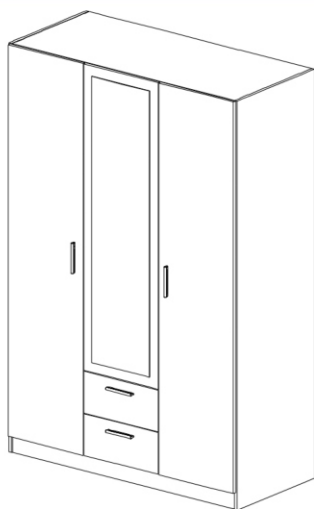

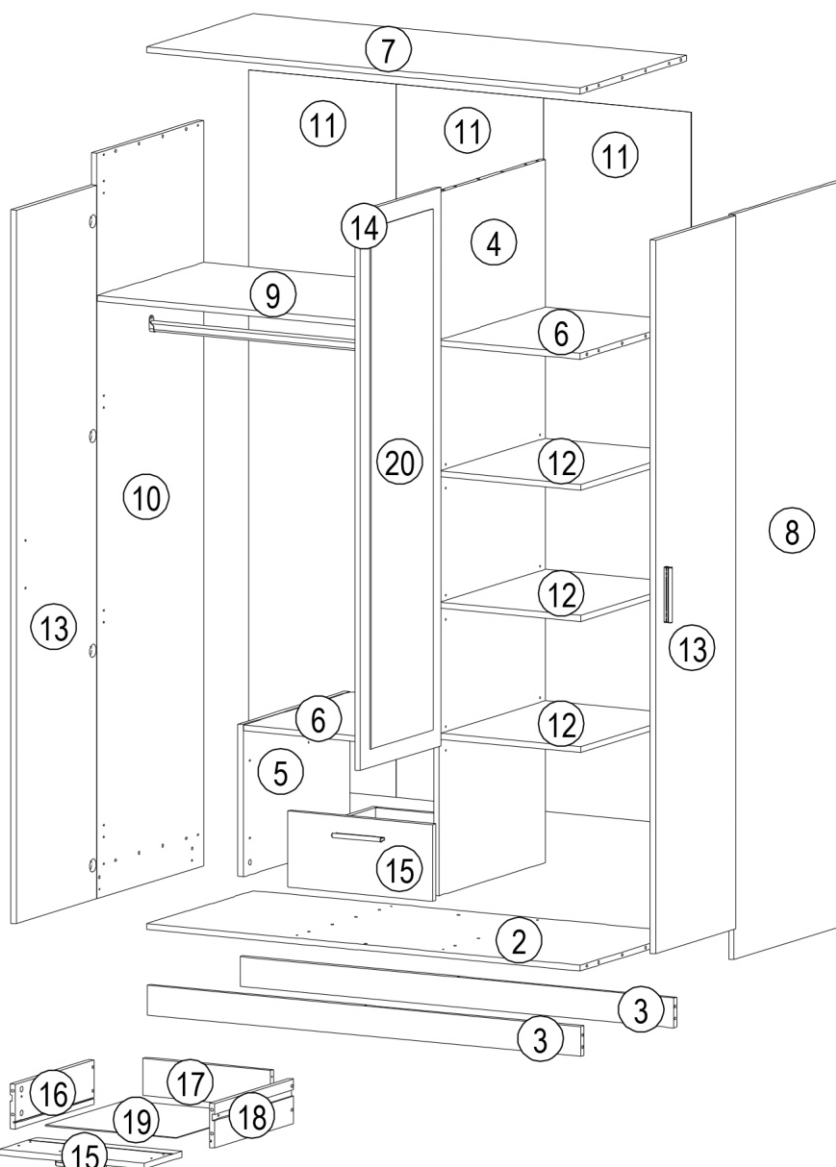



	1342	mm
	2000	
	600	

11613		1310*579*16	1x	2/4
11614		1310*80*16	2x	2/4
11615		1887*579*16	1x	4/4
11616		409*579*16	1x	2/4
11618		426*579*16	2x	2/4 4/4
11619		1310*579*16	1x	2/4
11576		2000*580*16	1x	1/4
11583		868*579*16	1x	2/4
11584		2000*580*16	1x	1/4
11620		1914*446*2,5	3x	1/4
11578		426*574*16	3x	4/4
11579		1914*438*16	2x	3/4
11622		1498*438*16	1x	3/4
11623		438*205*16	2x	3/4
11660		430*120*16	2x	4/4
11624		386*100*16	2x	2/4
11661		430*120*16	2x	4/4
11625		436*396*2,5	2x	2/4
11626		1398*338*3	1x	3/4









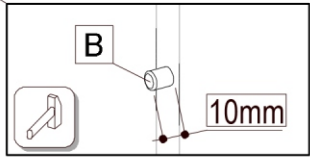
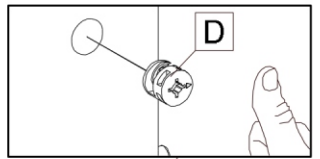
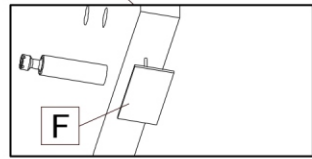
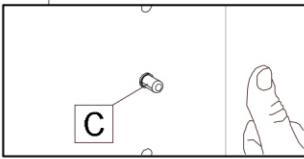
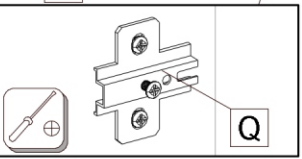
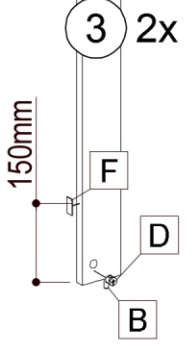
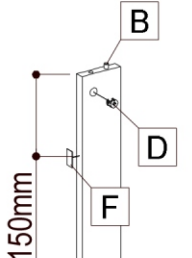
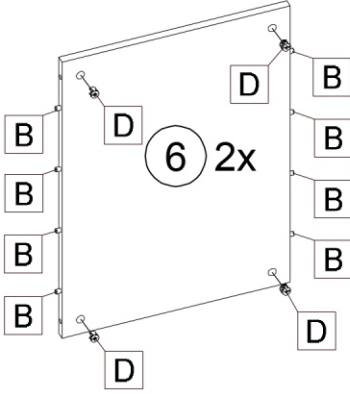
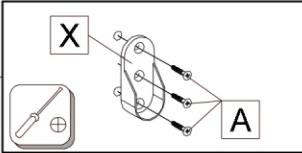
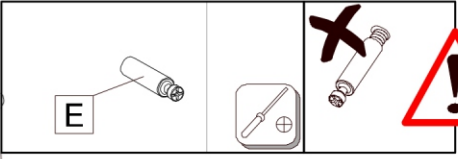
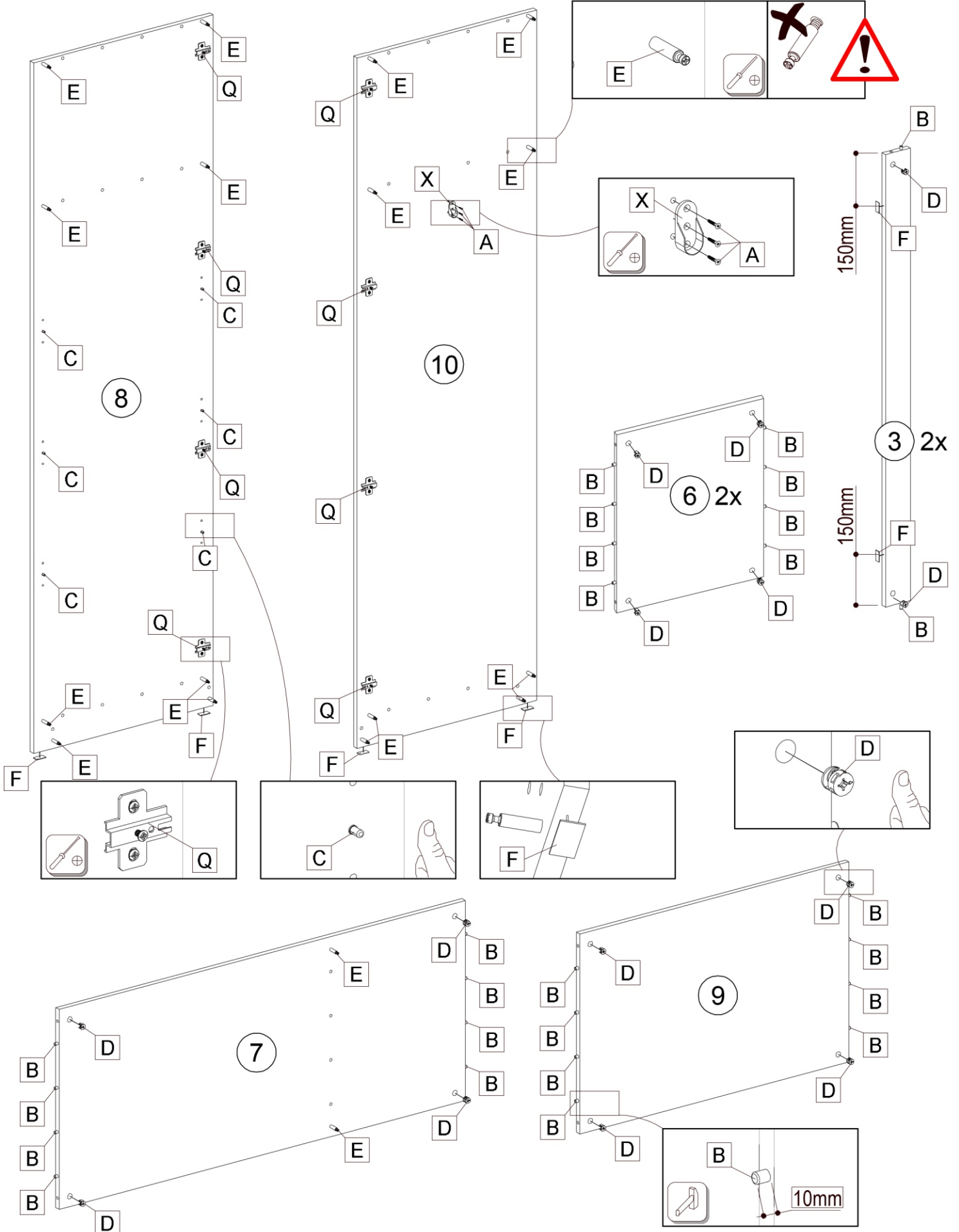

22243,00 Ø3,5x15 A 28x	27000,00 Ø8x30 B 56x	35101,01 C 12x	70013,01 D 38x	70021,01 E 38x	30090,00 F 8x	21102,00 Ø1,2x20 G 75x	31103,00 H 1x	22244,01 Ø3,5x16 J 10x	24103,00 Ø8 K 1x
22213,00 Ø4x70 L 1x	 M 22x	32030,00 N 4x	36013,02 P 11x	36013,02 Q 11x	 R 8x	22300,00 Ø7x50 S 10x	22502,00 M4x12 T 4x	22705,00 Ø6,3x8 U 8x	22236,00 Ø2,5x16 V 20x
24008,00 W 20x	70018,01 X 2x	50553,00 Y 2x	33018,00 Z 2x	70017,06 859mm Z1 1x	 4				





		180 min		PZ1, PZ2		3m	600 mm		

							
A	B	C	D	E	F	Q	X
3x	36x	6x	20x	18x	8x	8x	1x

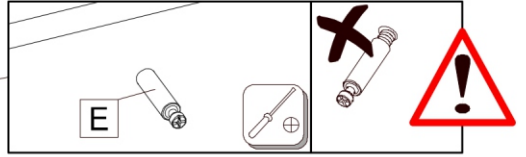
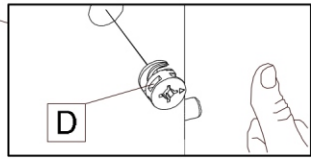
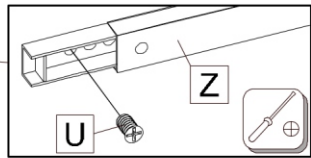
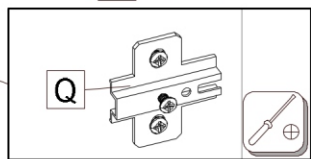
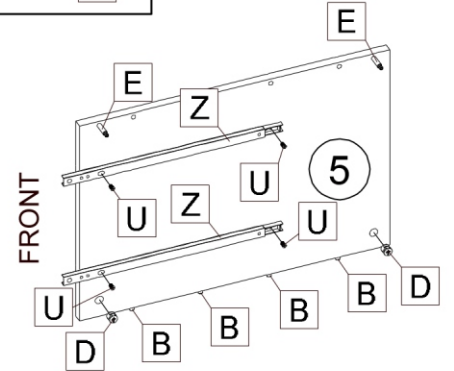
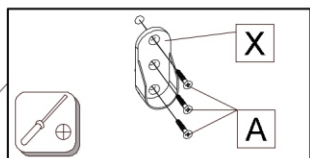
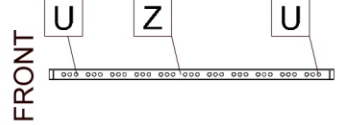
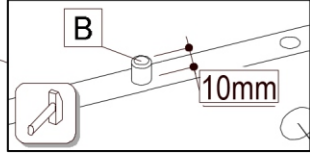
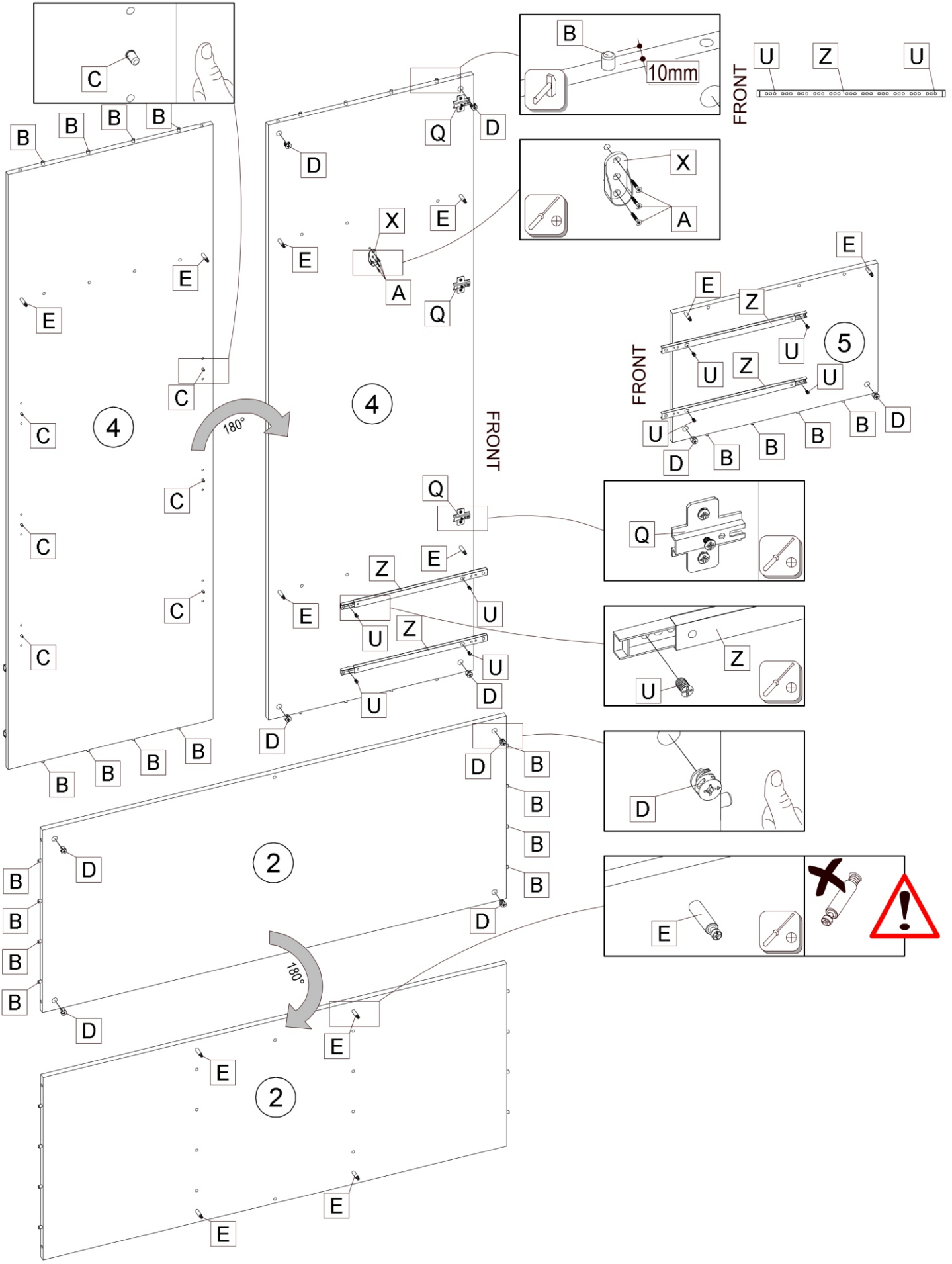

																	
A	3x	B	20x	C	6x	D	10x	E	12x	Q	3x	U	8x	X	1x	Z	2x

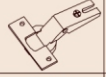

			
Ø3,5x15			
A 22x	N 2x	P 11x	R 4x

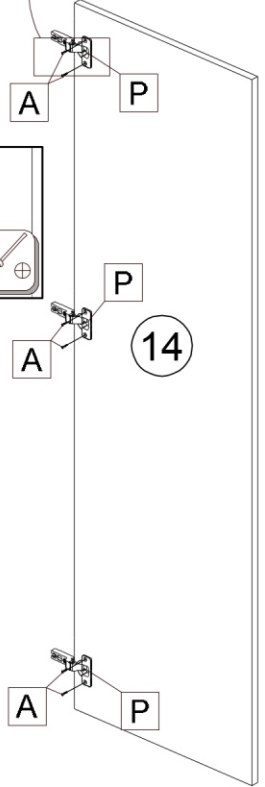
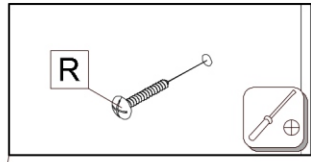
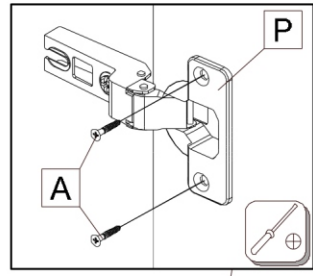
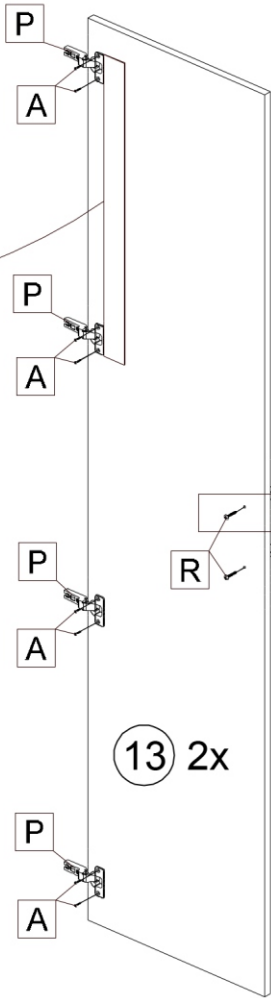
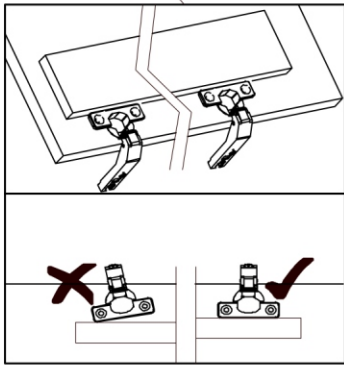



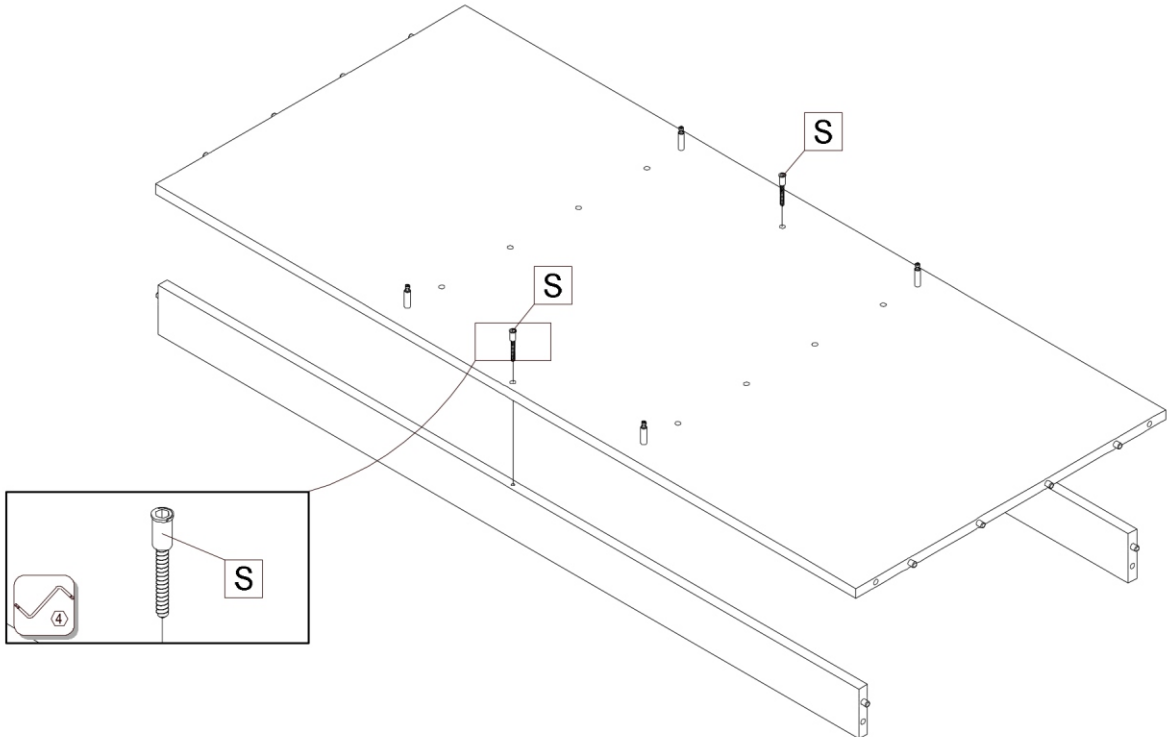

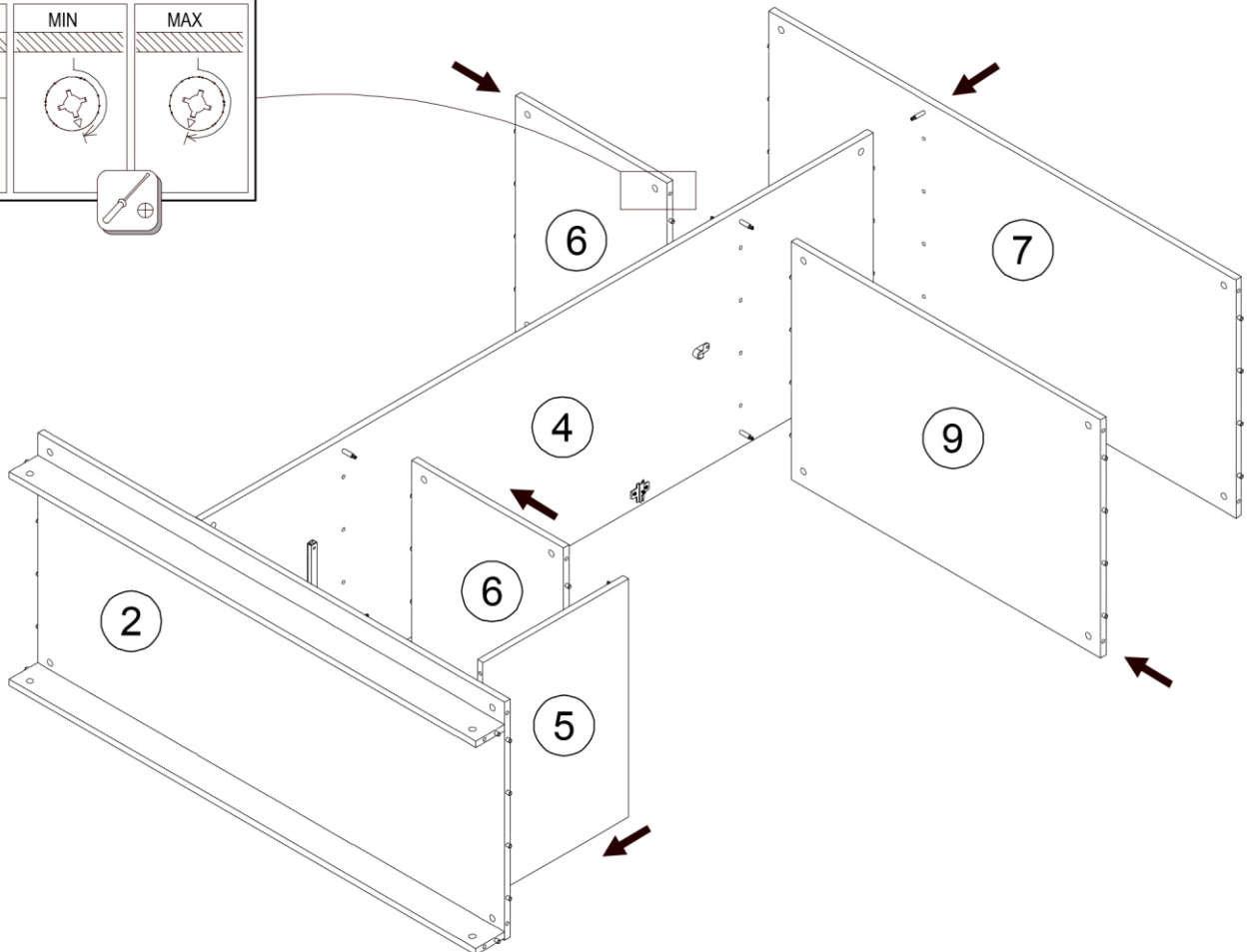
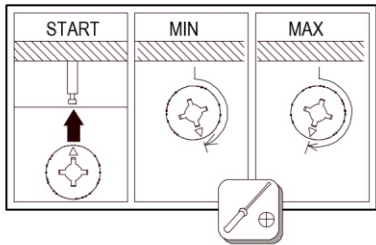
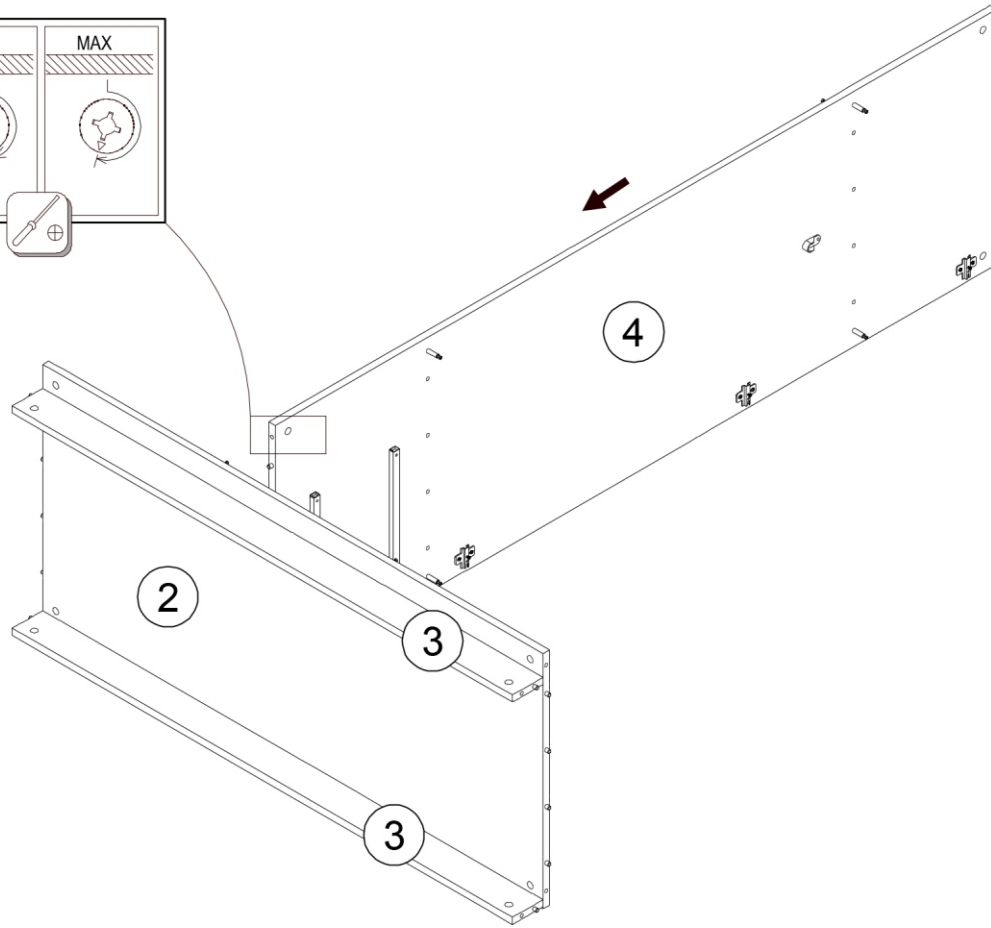
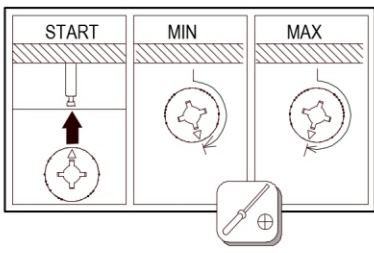
Ø7x50
S 2x

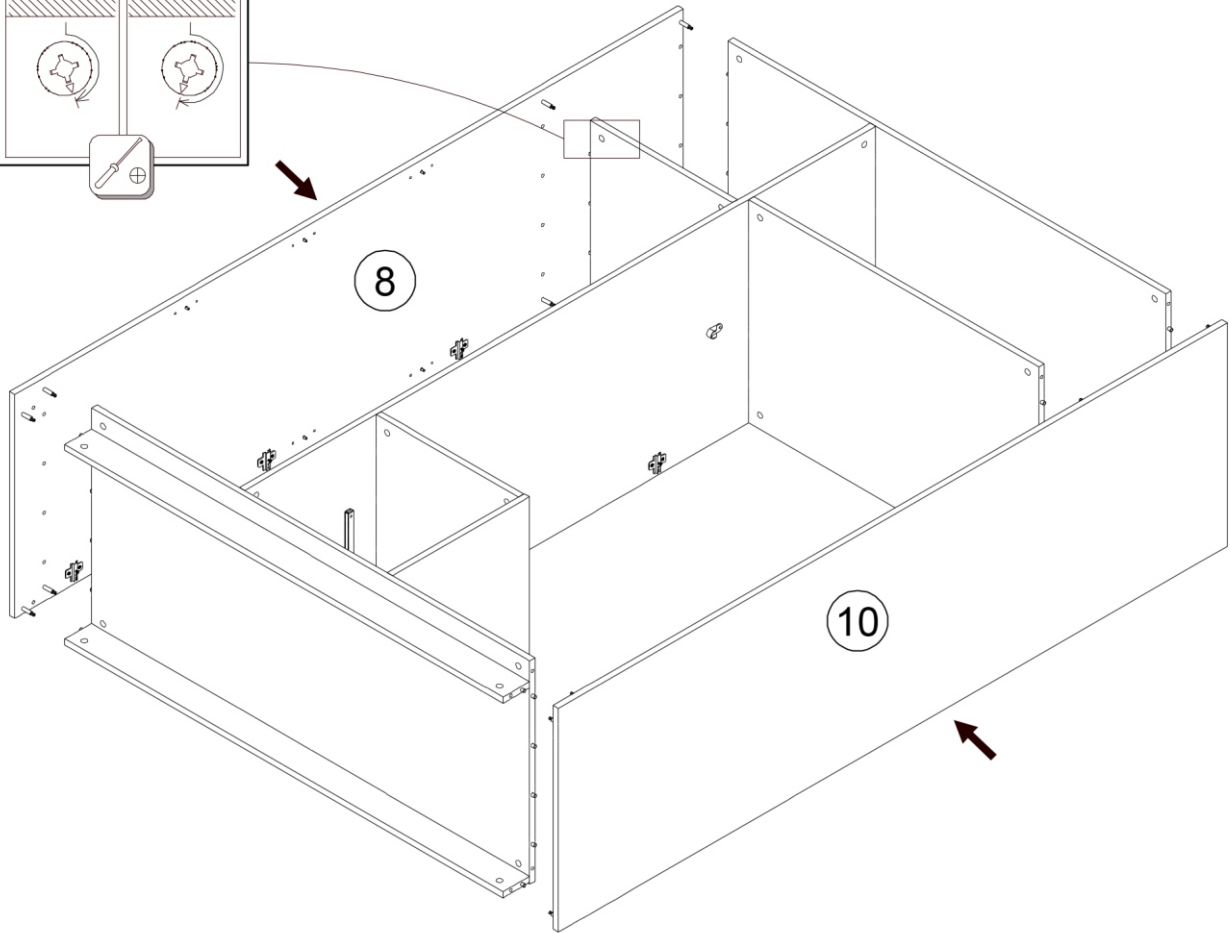
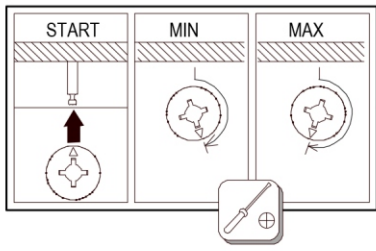



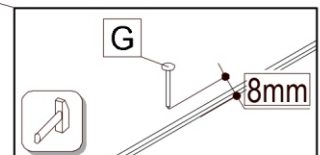
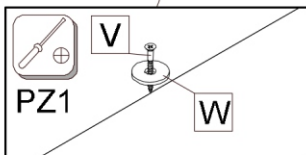
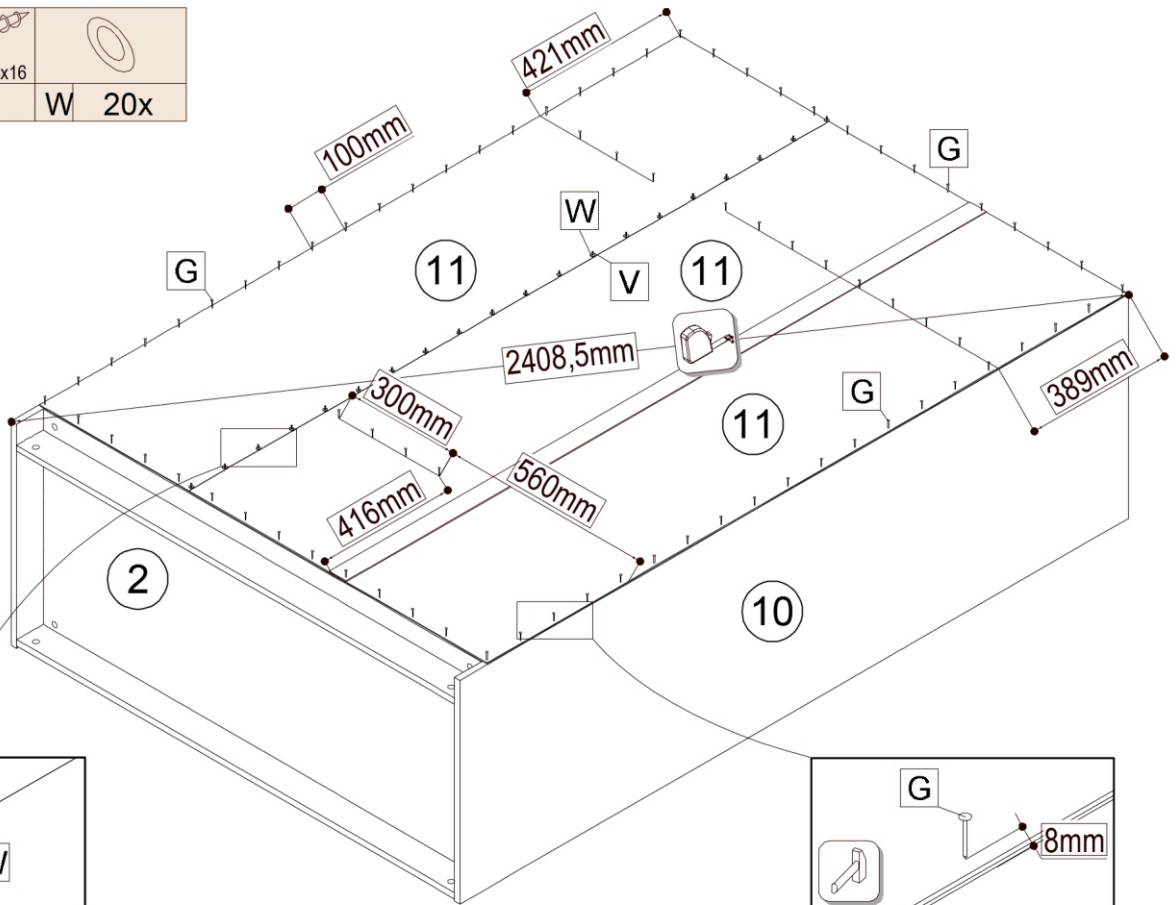

		
Ø1,2x20	Ø2,5x16	
G 75x	V 20x	W 20x



H 1x	J 2x
K 1x	L 1x

v=1965 **1.**

Ø8 **2.**

3.

4.

5.

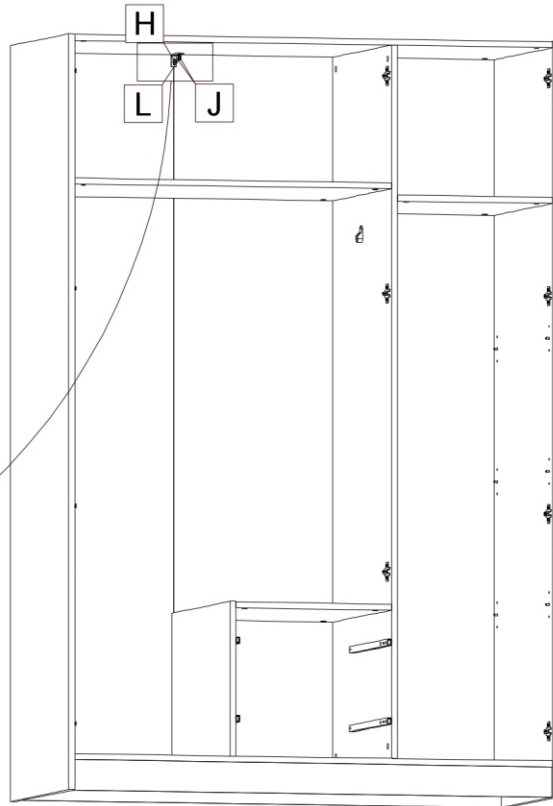
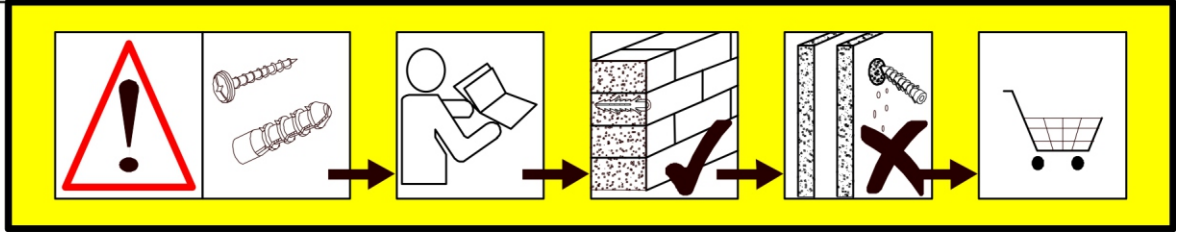

DE

Achtung! Die Wandbeschaffenheit ist vor der Montage unbedingt zu prüfen. Die beigelegten Universaldübel sind ausschließlich nur zur Verwendung für festes Mauerwerk wie Beton/Ziegel. Die Mauerdübel dürfen nicht bei Mauerwerk wie Hohlraumziegel, Leichtbausteinen, Gipskartonplatte oder anderer Rahmenbauweise verwendet werden. Bei diesen Mauerwerken sind gegebenenfalls Spezialdübel zu verwenden! Diese sind in einem Fachgeschäft (Baumarkt) erhältlich. Bei Nichteinhaltung wird seitens Produzenten/Händler und Importeur keine Haftung übernommen.

SK

Upozornenie! Pevnosť steny sa musí pred montážou bezpodmienečne skontrolovať. Univerzálne hmoždenky, ktoré sú obsiahnuté v balení, používajte jedine pre pevné murivo ako je betón/tehla. Hmoždenky sa nesmú používať v prípade ľahkého stavebného muriva, dutina tehla, u sádrokartónových dosiek alebo iných konštrukcií rámu. U týchto murív je nutné použiť špeciálne hmoždenky! Tieto je možné dostať v špeciálnych predajniach so stavebným materiálom (stavebniny). Pri nedodržaní pokynov nepreberajú výrobcovia/predajci a dodávateľa zodpovednosť za vzniknuté škody.

HU





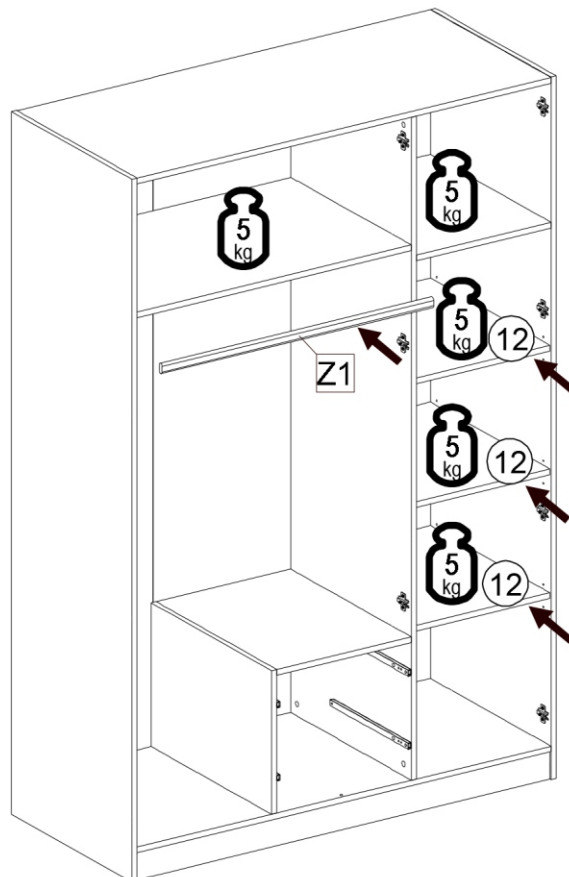

Vigyázat! Szerelés előtt a falfelületet feltétlenül vizsgálja meg. A mellékelt univerzális tiplik kizárólag stabil falazathoz használható mint például beton/tégla. A fal tiplik nem használható könnyű építőkövek hez, üreg tégla, gipszkarton lapokhoz vagy más favázás építményekhez. Ezekhez a falfelületekhez csak speciális tiplik használhatóak, melyek szaküzletekben (barkácsáruházakban) beszerezhetőek. Fentiek figyelmen kívül hagyása esetén a gyártó/kereskedő vagy forgalmazó nem vállal felelősséget.

CZ

Upozornění! Před montáží je nutné zkontrolovat stav stěny. Příložené univerzální hmoždinky jsou určeny pouze k použití pro pevné zdivo jako beton/cihly. Hmoždinky do zdi se nesmí používat u dutinová cihla, zdiva jako pórovitý stavební kámen, sádrokartónová deska nebo jiný měkký materiál. U těchto zdív jsou nutné použít speciální hmoždinky! Jsou k dostání v speciálních prodejnách se stavebním materiálem. Při nedodržení těchto pokynů výrobce/prodejce a dovozce neručí za způsobené škody.

Z1 1x



						
D 8x	E 8x	J 8x	N 2x	R 4x	S 8x	Y 2x
		Ø3,5x16			Ø7x50	

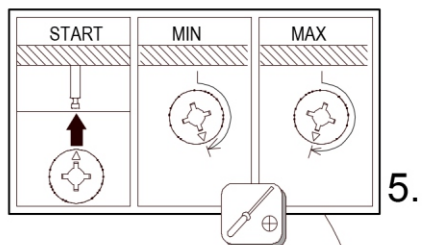
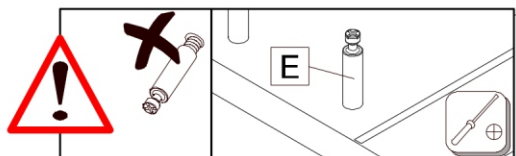
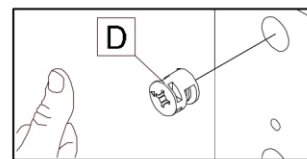
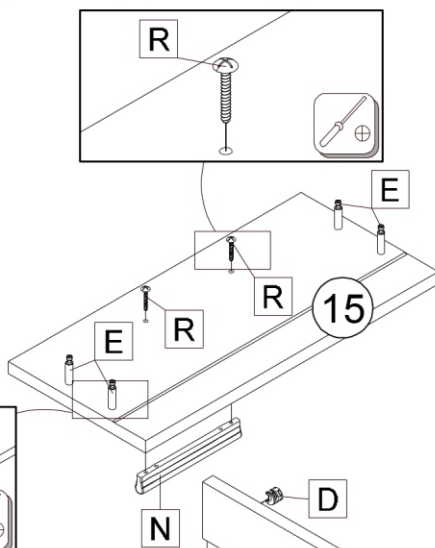
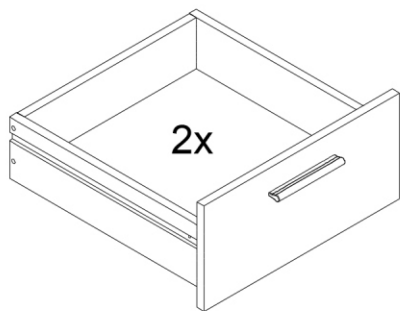

2.

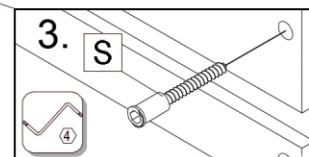
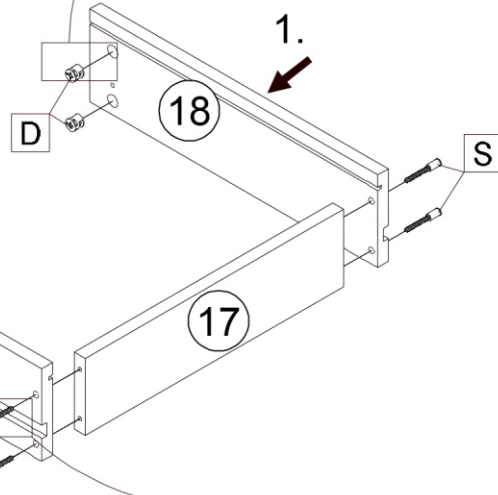

4.

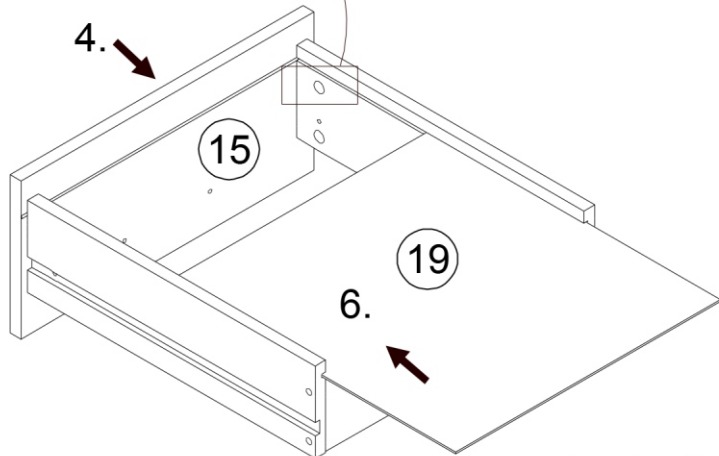

6.

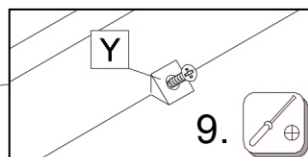
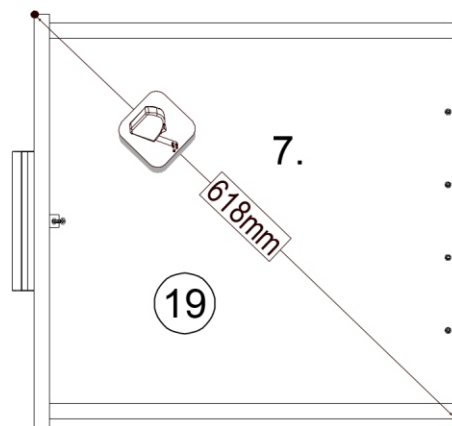

9.

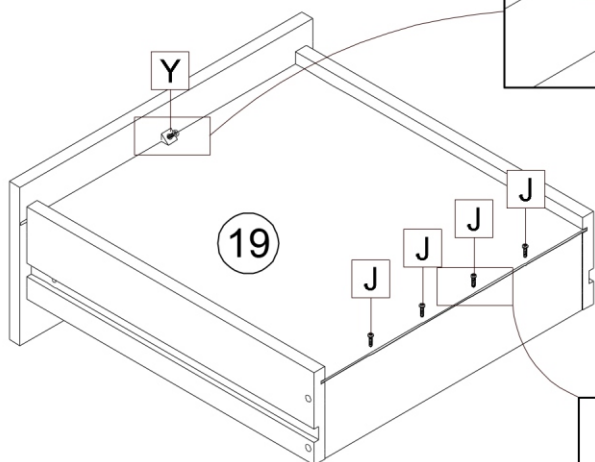

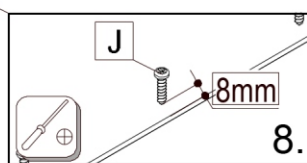

19

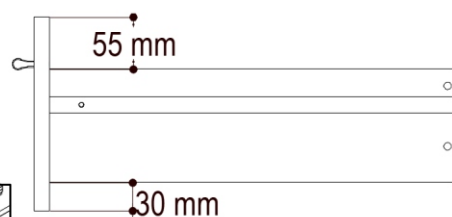

8.

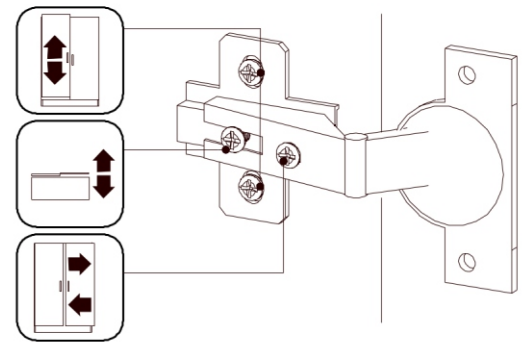
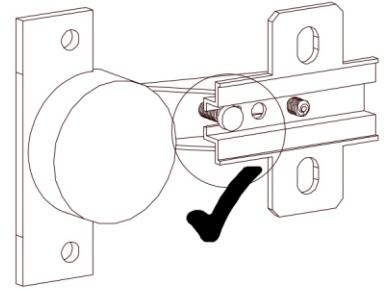
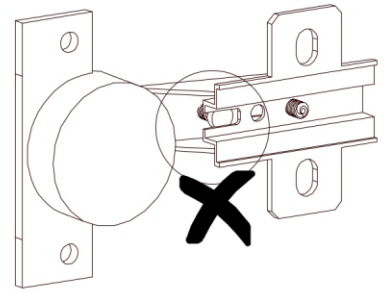
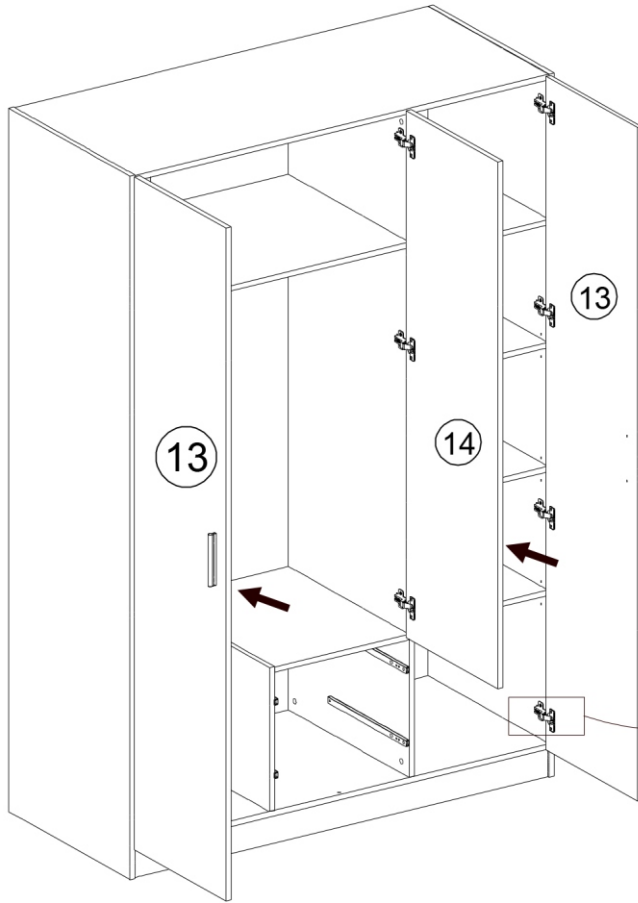



	
M 8x	T 4x

